

AIR FREIGHT

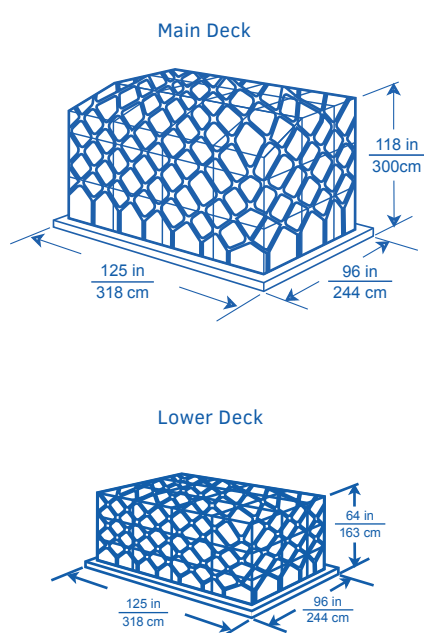

MAIN DECK:
30 pallets

LOWER DECK:
9 pallets

MAXIMUM PAYLOAD:
120,000 kg

B747-400F

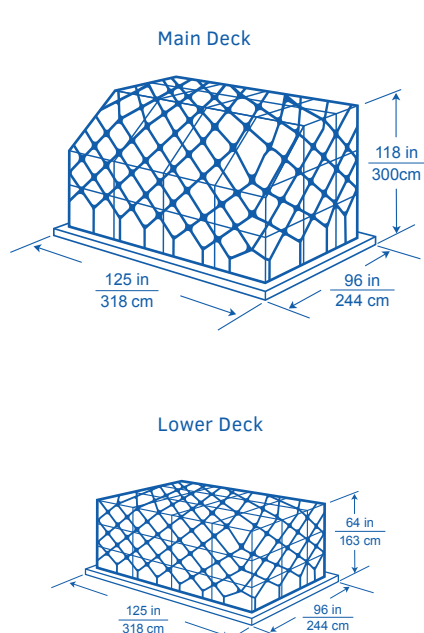
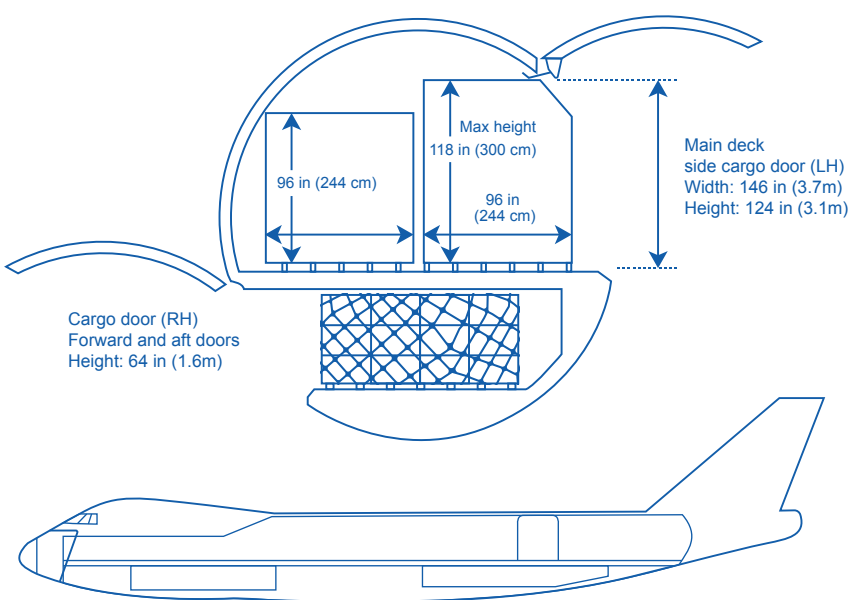

MAIN DECK:
27 pallets

LOWER DECK:
9 pallets

MAXIMUM PAYLOAD:
103,000 kg

B777-200F

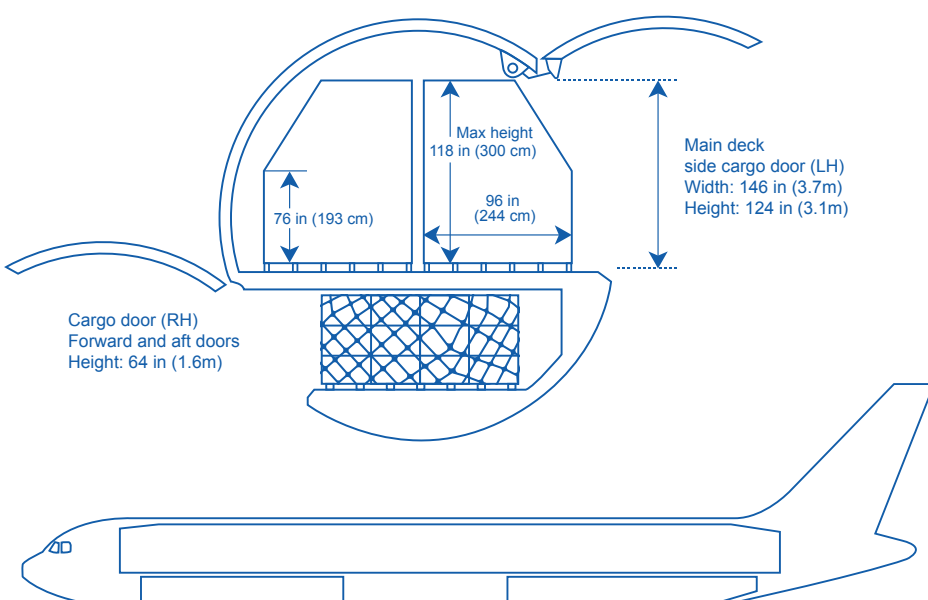

OCEAN FREIGHT

20' CONTAINER

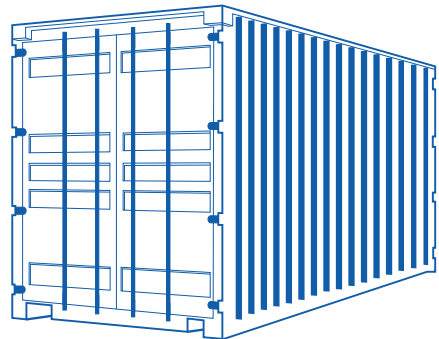

INSIDE DIMENSIONS:
232 (L) x 92 (W) x 94 (H) in
589 (L) x 233 (W) x 238 (H) cm

DOOR OPENING:
90 x 89 in
228 x 226 cm

40' CONTAINER

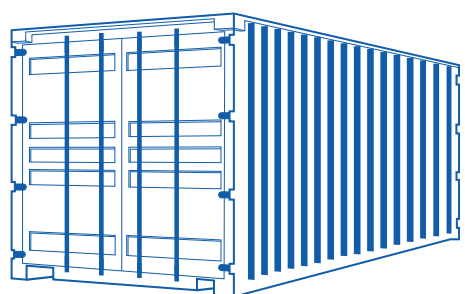

INSIDE DIMENSIONS:
473 (L) x 92 (W) x 94 (H) in
1201 (L) x 233 (W) x 238 (H) cm

DOOR OPENING:
90 x 89 in
228 x 226 cm

40' HIGH CUBE



INSIDE DIMENSIONS:
473 (L) x 92 (W) x 103 (H) in
1201 (L) x 233 (W) x 261 (H) cm

DOOR OPENING:
90 x 101 in
228 x 254 cm

TRUCKING

US 53'

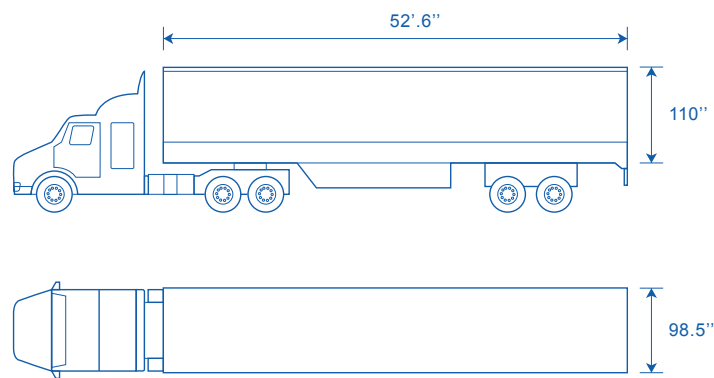

INSIDE DIMENSIONS:
630 (L) x 99 (W) x 110 (H) in
1600 (L) x 251 (W) x 279 (H) cm

DOOR OPENING:
99 x 110 in
251 x 279 cm

WEIGHT CAPACITY:
42,000 lbs
19,050 kgs

MEGACUBE EURO

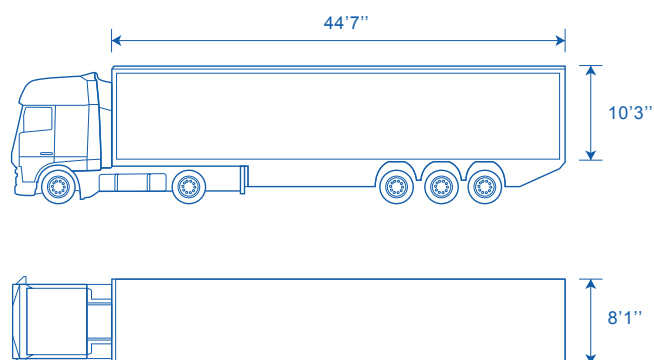

INSIDE DIMENSIONS:
535 (L) x 97 (W) x 123 (H) in
1359 (L) x 246 (W) x 312 (H) cm

DOOR OPENING:
97 x 123 in
246 x 312 cm

WEIGHT CAPACITY:
50,000 lbs
22,700 kgs

ASIA

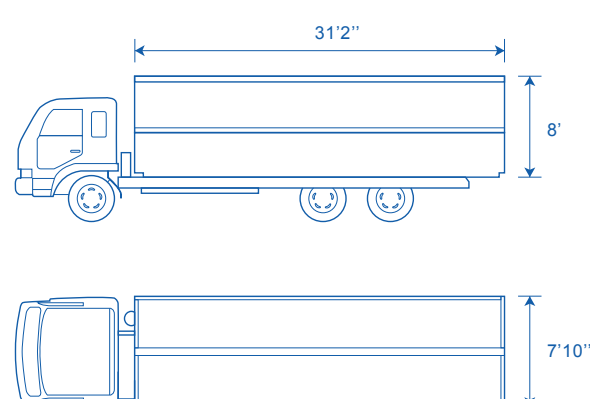

INSIDE DIMENSIONS:
374 (L) x 94 (W) x 101 (H) in
950 (L) x 239 (W) x 258 (H) cm

DOOR OPENING:
91 x 97 in
231 x 248 cm

WEIGHT CAPACITY:
24,000 lbs
10,900 kgs

